

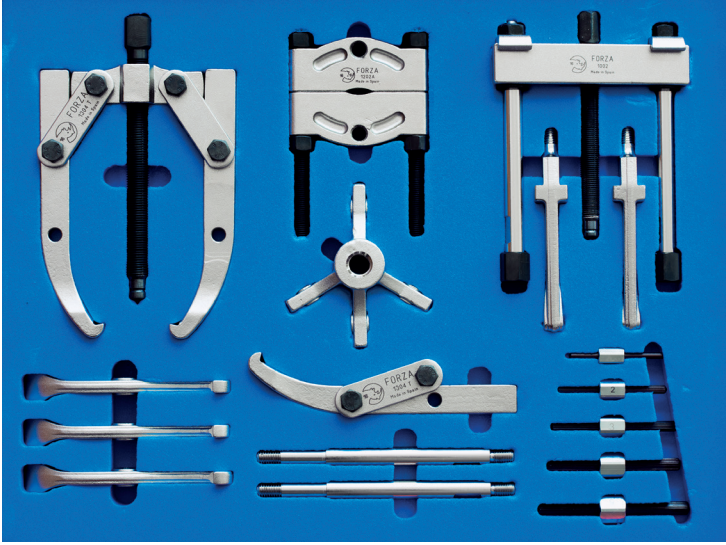

4 Ton Kapasiteli Mekanik Çektirme Seti

4 Ton Capacity Mechanical Puller Kit



Ürün Kodu : FMK400

- » 2 kollu kısa çapraz çektirme
- » 2 kollu rulman kasnak çakma
- » 2 kollu ay tip rulman - kasnak çektirme
- » 2/3 kollu standart tip içten çektirme
- » 2/3 kollu Standart tip dıştan çektirme
- » M6 - M20 saplama sökme milleri

Product Code: FMK400

- » 2 jaws short type cross puller
- » 2 jaws bearing pusher
- » 2 jaws moon type bearing puller
- » 2/3 jaws standard type internal puller
- » 2/3 jaws standard type external puller
- » M6 - M20 broken bolt extractor

Aşağıda yer alan tüm ürünler ayrı ayrı sipariş edilebilir.
All products listed below can be ordered separately.

Ürün Kodu : 1002

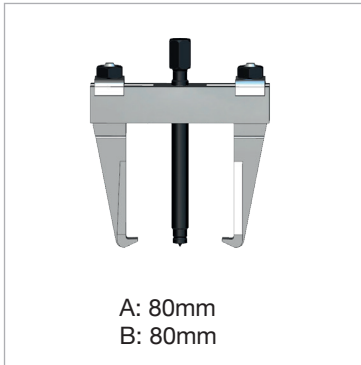

Ürün Kodu : 1102



Ürün Kodu : 1202A

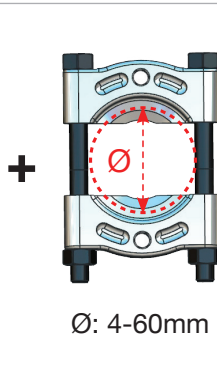

1102+1202A

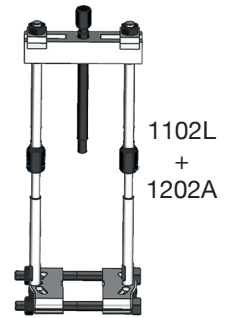
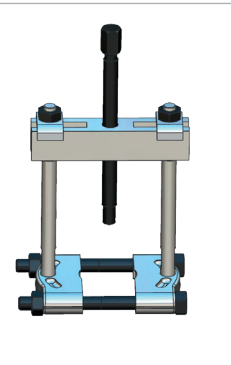

Ürün Kodu : 1304



Ürün Kodu : 1304T

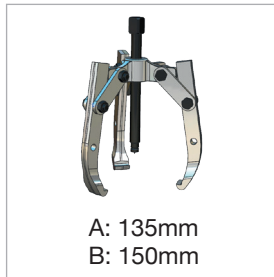

Ürün Kodu : 1404

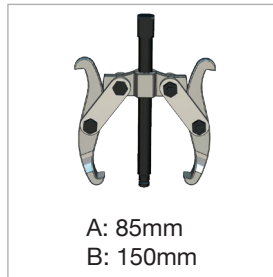

Ürün Kodu : 1404T

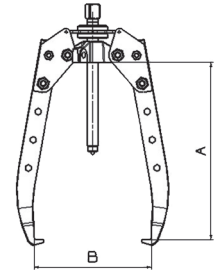
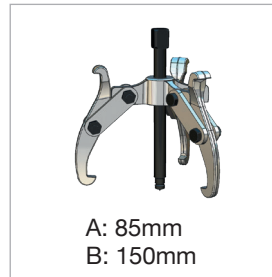

Ürün Kodu : 5010

M6-M20



Saplama Çektirme Milleri

