

EVOTORQUE[®] 2



CONTENTS

Part Numbers Covered by This Manual	2
Description Options	2
Serial Number	2
Safety – General Power Tool Safety Warnings	3
Work Area Safety	3
Electrical Safety	3
Personal Safety	4
Power Tool Use and Care	4
Service	4
Safety – EvoTorque® 2 Specific Safety Warning	5
Markings on Tool	5
EvoTorque® 2 Tools without Reaction Bar	5
Introduction	6
Parts Included	6
Accessories	7
Features and Functions	8
Set Up Instructions	10
Top Handle	10
Torque Reaction	11
Connecting Supply	15
Turn On	16
Set Direction	16
Set Up Targets	17
View / Select Work Group, Work IDs	18
View / Select Users	18
Tool Settings	19
View Results	20
Tool Information	22
Operating Instructions	24
Tightening	24
Saving Results	26
Releasing	26
Maintenance	27
Daily Checks	27
Calibration	27
Portable Appliance Testing	27
Gearbox	28
Drive Square	28
Product Disposal	28
Specifications - EvoTorque® 2	29
Specifications - USB Bluetooth® Smart adapter	31
Declaration of Conformity	33
Trouble Shooting	34
Glossary of Terms	35

PART NUMBERS COVERED BY THIS MANUAL

This manual covers the set up and use of Norbar EvoTorque® 2 tools.

Part Number	Model	Torque Range
180230.B06	ET2-72-1000-110	100 - 1000 N·m *
180220.B06	ET2-72-1000-230	100 - 1000 N·m *
180231.B06	ET2-72-1350-110	135 – 1350 N·m *
180221.B06	ET2-72-1350-230	135 - 1350 N·m *
180232.B08	ET2-72-2000-110	200 - 2000 N·m *
180222.B08	ET2-72-2000-230	200 - 2000 N·m *
180233.B08	ET2-92-2700-110	270 - 2700 N·m *
180223.B08	ET2-92-2700-230	270 - 2700 N·m *
180234.B08	ET2-92-4000-110	400 - 4000 N·m *
180224.B08	ET2-92-4000-230	400 - 4000 N·m *
180235.B12	ET2-119-6000-110	600 - 6000 N·m *
180225.B12	ET2-119-6000-230	600 - 6000 N·m *
180236.B12	ET2-119-7000-110	700 - 7000 N·m *
180226.B12	ET2-119-7000-230	700 - 7000 N·m *

* Note: Calibrated Range of each tool is 20% - 100% Torque Capacity

NOTE: The main EvoTorque® 2 models are listed above; other tools with minor variances are also covered.

Description Options

Part Number Option	Description	Options
****.B**	B = Bi-directional	None
****.XX	Drive square size	06 = 3/4" A/F. 08 = 1" A/F. 12 = 1 1/2" A/F.

Model Option	Description	Options
ET2-***-****-***	ET2 = EvoTorque® 2	None
ET2-XXX-****-***	Gearbox diameter	72 / 92 / 119
ET2-***-XXXX-***	Maximum torque in N·m	1000 / 1350 / 2000 / 2700 / 4000 / 6000 / 7000
ET2-***-****-XXX	Mains supply voltage	110=110 V a.c. / 230=230 V a.c.



Serial Number

The serial number is in the following format: **YYYYAXXXXX**

Serial Number Code	Description	Options
YYYY*****	Year of manufacture	
****A*****	Month of manufacture	A=January B= February C= March D= April E= May F=June G=July H=August J=September K=October L=November M=December
****XXXXX	Serial number	

NOTE: Due to the manufacturing process, the calibration date may be after the month of manufacture.

SAFETY – GENERAL POWER TOOL SAFETY WARNINGS

Symbol	Meaning
	The lightning flash is intended to alert the user to the presence of uninsulated “dangerous voltage” within the products enclosure that may be of sufficient magnitude to constitute a risk of electric shock to persons.
	The exclamation mark is intended to alert the user to the presence of important operating and maintenance (servicing) instructions in the manual.



WARNING: READ ALL SAFETY WARNINGS AND ALL INSTRUCTIONS. FAILURE TO FOLLOW THE WARNINGS AND INSTRUCTIONS MAY RESULT IN ELECTRIC SHOCK, FIRE AND/OR SERIOUS INJURY.

Save all warnings and instructions for future reference.

The term “power tool” in the warnings refers to your mains-operated (corded) power tool or battery operated (cordless) power tool.

Work Area Safety

- Keep work area clean and well lit. Cluttered or dark areas invite accidents.
- Do not operate power tools in explosive atmospheres, such as in the presence of flammable liquids, gases or dust. Power tools create sparks which may ignite the dust or fumes.
- Keep children and bystanders away while operating a power tool. Distractions can cause you to lose control.

Electrical Safety

- Power tool plugs must match the outlet. Never modify the plug in any way. Do not use any adaptor plugs with earthed (grounded) power tools. Unmodified plugs and matching outlets will reduce risk of electric shock.
- Avoid body contact with earthed or grounded surfaces, such as pipes, radiators, ranges and refrigerators. There is an increased risk of electric shock if your body is earthed or grounded.
- Do not expose power tools to rain or wet conditions. Water entering a power tool will increase the risk of electric shock.
- Do not abuse the cord. Never use the cord for carrying, pulling or unplugging the power tool. Keep cord away from heat, oil, sharp edges and moving parts. Damaged or entangled cords increase the risk of electric shock.
- When operating a power tool outdoors, use an extension cord suitable for outdoor use. Use of a cord suitable for outdoor use reduces the risk of electric shock.
- If operating a power tool in a damp location is unavoidable, use a residual current device (RCD) protected power supply. Use of an RCD reduces the risk of electric shock.
- When performing an operation where the fastener may contact hidden wiring or its own cord, hold power tool by insulated gripping surface (e.g. insulating gloves). Fasteners containing a “live” wire may make exposed metal parts of the power tool “live” and could give the operator an electric shock.

Personal Safety

- Stay alert, watch what you are doing and use common sense when operating a power tool. Do not use a power tool while you are tired or under the influence of drugs, alcohol or medication. A moment of inattention while operating power tools may result in serious personal injury.
- Use personal protective equipment. Always wear eye protection. Protective equipment such as dust mask, non-skid safety shoes, hard hat or hearing protection used for appropriate conditions will reduce personal injuries.
- Prevent unintentional starting. Ensure the switch is in the off-position before connecting to power source and/or battery pack, picking up or carrying the tool. Carrying power tools with your finger on the switch or energising power tools that have the switch on invites accidents.
- Remove any adjusting key or wrench before turning the power tool on. A wrench or a key left attached to a rotating part of the power tool may result in personal injury.
- Do not overreach. Keep proper footing and balance at all times. This enables better control of the power tool in unexpected situations.
- Dress properly. Do not wear loose clothing or jewellery. Keep your hair, clothing and gloves away from moving parts. Loose clothes, jewellery or long hair can be caught in moving parts.
- If devices are provided for the connection of dust extraction and collection facilities, ensure these are connected and properly used. Use of dust collection can reduce dust related hazards.

Power Tool Use and Care

- Do not force the power tool. Use the correct power tool for your application, this will do the job better and safer at the rate for which it was designed.
- Do not use the power tool if the switch does not turn it on or off. Any power tool that cannot be controlled with the switch is dangerous and must be repaired.
- Disconnect the plug from the power source and/or the battery pack from the power tool before making any adjustments, changing accessories or storing power tools. Such preventative measures reduce the risk of starting the power tool accidentally.
- Store idle power tools out of reach of children and do not allow persons unfamiliar with the power tool or these instructions to operate the power tool. Power tools are dangerous in the hands of untrained users.
- Maintain power tools. Check for misalignment or binding of moving parts, breakage of parts and any other condition that may affect operation. If damaged, have the power tool repaired before use. Many accidents are caused by poorly maintained power tools.
- Keep cutting tools sharp and clean. Properly maintained cutting tools with sharp edges are less likely to bind and are easier to control.
- Use the power tool, accessories and tool bits etc. in accordance with these instructions, taking into account the working conditions and the work to be performed. Use of the power tool for operations away from those intended could result in a hazardous situation.

Service

- Have your power tool serviced by a qualified repair person using only identical replacement parts. This will ensure that the safety of the power tool is maintained.

SAFETY – EVOTORQUE[®]2 SPECIFIC SAFETY WARNING

This tool is intended for use with threaded fasteners.



WARNING: IF NOT USED PROPERLY THIS PRODUCT CAN BE DANGEROUS! THIS PRODUCT CAN CAUSE SERIOUS INJURY TO THE OPERATOR AND OTHERS, THE WARNINGS AND SAFETY INSTRUCTIONS MUST BE FOLLOWED TO ENSURE REASONABLE SAFETY AND EFFICIENCY IN USING THIS PRODUCT. THE OPERATOR IS RESPONSIBLE FOR FOLLOWING THE WARNING AND SAFETY INSTRUCTIONS IN THIS MANUAL AND ON THE PRODUCT.

- Understand the operation of both the TORQUE mode and the ANGLE mode, especially when applied to pre-tightened fasteners. Incorrect tool use can easily apply excessive torque.
- Do not block cooling air entry and exit points.
- Do not pull the mains cable to disconnect from AC outlet, grasp the plug.
- Store tool in carry case after use.
- Isolate the tool from all energy sources before changing or adjusting the drive square socket.
- Always use impact or high quality sockets.
- Use only sockets and adaptors which are in good condition.
- Use only sockets and adaptors which are intended for use with power tools.
- Always operate with a reaction bar that is free to move. Do not fix reaction bar to reaction point.
- For very low torque rate joints (e.g. heat exchangers with long rundown threads) the tool will get warm. In extreme cases the tool safety temperature control will stop the tool.
- It is recommended that Portable Appliance Testing (PAT Testing), officially known as “In-Service Inspection & Testing of Electrical Equipment” is completed at regular intervals, see MAINTENANCE section for more information.

Markings on Tool

Pictograms on Tool	Meaning
	WARNING: LIVE PARTS INSIDE. DO NOT REMOVE COVER. NO USER SERVICEABLE PARTS INSIDE.
	Unexpected tool movement due to reaction forces or breakage of drive square or reaction bar may cause injuries. There is a risk of crushing between the reaction bar and work piece. Keep hands away from reaction bar. Keep hands away from tool output.
	Read and understand Operator’s Manual.

EvoTorque[®]2 Tools without a Reaction Bar

Upon customer request some EvoTorque[®]2 tools are supplied without a reaction bar. These tools MUST NOT be used until a suitable reaction bar has been fitted. Norbar define the reaction bar as ‘interchangeable equipment’ under the European directive 2006/42/EC on Machinery Safety. If applicable a new reaction bar will need to comply with this directive.



INTRODUCTION

The EvoTorque[®]2 is an electronic torque tool designed for applying torque to threaded fasteners. There are models to cover torque capacities of 1000 N·m to 7000 N·m. The unique ‘Intelligent Joint Sensing’ technology will accurately tighten to the correct torque without the risk of excess overshoot or undershoot that is common in other electric tools. For fasteners specified in angle, there is an angle mode. Positive confirmation of correct joint tightening is shown on the tool.

The EvoTorque[®]2 has the ability to memorize multiple Targets, Work ID’s, User ID’s and Readings. Up to 5 Work Groups can co-exist on the EvoTorque[®]2 which can be sequential or user selectable.

The EvoTorque[®]2’s functionality is greatly enhanced when used with the EvoLog PC/Tablet software included with the tool. Connection is possible via USB or the USB Bluetooth[®] Smart adapter (included).



Parts Included

Description	Model		
	ET2-72	ET2-92	ET2-119
Maximum Torque	1000 N·m 1350 N·m 2000 N·m	2700 N·m 4000 N·m	6000 N·m 7000 N·m
Visual Difference			
Steel Reaction Bars	19289	19291	19293
Reaction Bar Retaining Circlip	26486	26486	26482
Spare Drive Square	18779 (1000 N·m) 19779 (1350 N·m) 18492 (2000 N·m)	18934	-
4mm Hex Key for Drive Square	24953	24953	-
Infill for Top Handle (2 off)	19128	19128	19128
5mm Hex Key for Top Handle	24952	24952	24952
Mains Adaptor (where required)	See table below	See table below	See table below
EvoTorque [®] 2 Operator’s Manual	34426	34426	34426
USB memory stick with EvoLog software & Operator’s Manual			
USB Bluetooth [®] Smart adapter	43513	43513	43513
USB lead (2 m)	39777	39777	39777

Mains Adaptor Part Number									
Mains Voltage	Socket (IEC 60309)	Plug							
		USA	UK	Euro	Italian	Swiss	Danish	Australian	No Plug
110 V	Yellow	39618	-	-	-	-	-	-	39623
230 V	Blue	-	39616	39617	39619	39621	39647	39620	39624

NOTE: The mains adaptors are NOT IP44 rated.

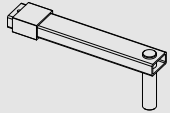
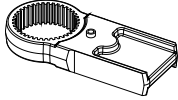
Accessories

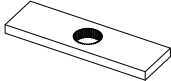
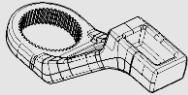
Description	Part Number		
	ET2-72	ET2-92	ET2-119
¾" Drive Square (Fixing Screw)	18779 (25325.45)	-	-
1" Drive Square (Fixing Screw)	18492 (25352.45)	18934 (25352.60)	-
1 ½" Drive Square (Fixing Screw)	-	18935 (25352.60)	18959 (25352.80)
Reaction Bar (NOTE) 	18298	-	-
Reaction Bar Adaptor (NOTE) 	18290	-	-
Single-Sided Reaction Plate 	18292	18979	16687
Double-Sided Reaction Plate 	18293	18980	18981
Cranked Reaction Foot 	18494	18936	18961
6" Blade Nose Extension	(1") 18755.006	-	-
9" Blade Nose Extension	(1") 18755.009	-	-
12" Blade Nose Extension	(1") 18755.012	-	-
9" Nose Extension for Truck and Bus Wheels	(¾") 19087.009 (1") 19089.009	-	-
12" Nose Extension for Truck and Bus Wheels	(¾") 19087.012 (1") 19089.012	-	-
Carry Case	26969	26970	26970

NOTE: Requires both "Reaction Bar" and "Reaction Bar Adaptor" to be used together.

Reactions to suit specific applications can be supplied, contact Norbar or a Norbar distributor for details.

FEATURES AND FUNCTIONS

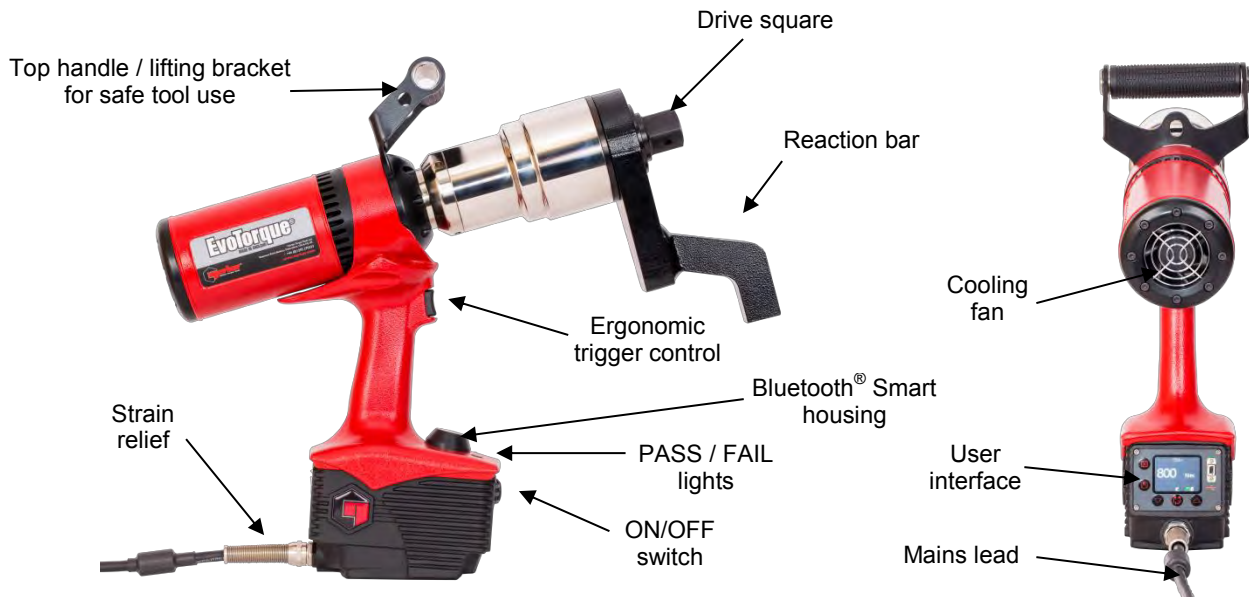

FIGURE 1 – Tool Features

- 3 operational modes – Torque, Torque & Angle or Torque Audit.

Mode	Description
Torque	Fast tightening of fastener to torque value.
Torque & Angle	Tightening to torque followed by angle specification for fastener.
Torque Audit	For checking pre-tightened fasteners.

- Colour Display.
- Display and on board storage of final Torque (& Angle) values.
- 3000 (time and date stamped) reading memory.
- USB & Bluetooth® data transfer.
- Complimentary PC software “EvoLog”.
- Display can be powered from USB for interface to EvoLog. No separate tool mains power required.
- Ability to download up to 12 User ID’s to the tool.
- 20 unique Standalone Targets +20 unique Work Group Targets for each Work Group.
- 12 Standalone Work ID’s +12 Work ID’s in each Work Group.
- Ability to have up to 5 Work Groups with a maximum of 144 steps, distributed over a maximum of 12 Work IDs on the tool.
- Send ‘Log Results’ in real time.
- Output results in CSV format.
- Factory calibrated to $\pm 3\%$.
- Ability to define pass fail result tolerances.
- Using patent pending “Intelligent Joint Sensing” technology to continually measure the joint during tightening. As the fastener is tightened the tool will sense the joint type (hard / soft) and act accordingly. As the fastener is tightened dynamic braking is used to ensure the target torque is correctly reached and eliminate the potential for a large over torque due to tool inertia.
- Models covering 7 torque ranges up to 7000 N·m.

- Very quiet operation.
- Very low vibration levels using a non-impacting mechanism; this leads to comfortable and safe use with less damage to the tool, socket and threaded assembly.
- IP44 environmental rating (protection against 1mm solid objects & splashing water).
- Versions for 110 V a.c. or 230 V a.c.
- Reaction forces are contained by the reaction bar, so forces are not passed back to the operator.
- Several reaction bar styles available, including versions for restricted applications.
- Tool operational from 10% to 100% (calibrated from 20% to 100%) of rated torque capacity.
- Brushless motor for low maintenance.

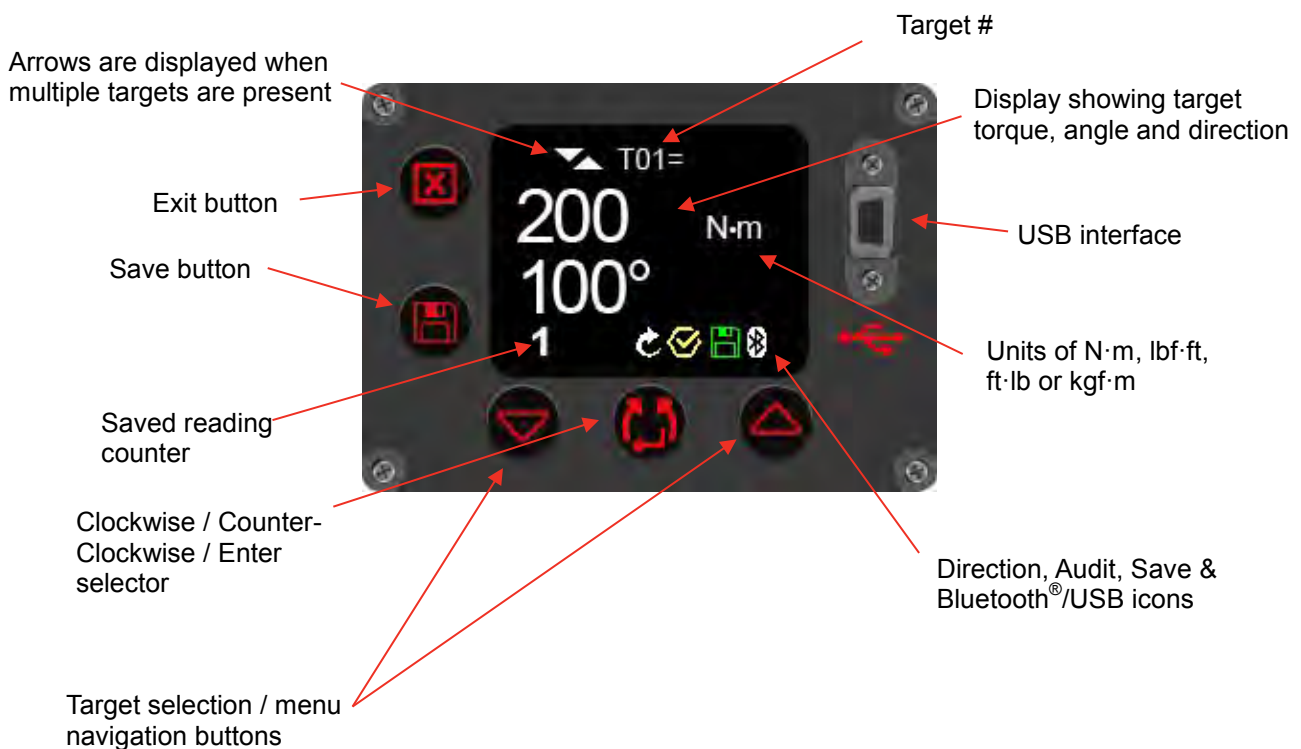

FIGURE 2 – User Interface Features

NOTE: The saved reading counter will be shown as 1/x, 2/x etc (where x is the 'Number of Readings' specified in a Target set up on EvoLog) when performing a Work Group. See EvoLog Operator's Manual (part # 34427) for more information.

SET UP INSTRUCTIONS

NOTE: If the equipment is used in a manner not specified by the manufacturer, the protection provided by the equipment may be impaired.



WARNING: ALLOW THE TOOL TO EQUALISE TO THE AMBIENT TEMPERATURE / HUMIDITY BEFORE SWITCHING ON. WIPE OFF ANY MOISTURE BEFORE USE.

Please complete the set up in the order shown.

Top Handle

The tool is supplied with a top handle attached to the tool. For hand held use it is recommended to always use the top handle as loss of tool control can cause personal injury. If a hanger (balancer) is required, attach to top handle.

Should the top handle not be required it can be removed as follows:

1. Use 5mm hex key (supplied) to remove fixing bolts, see figure 3, then remove handle

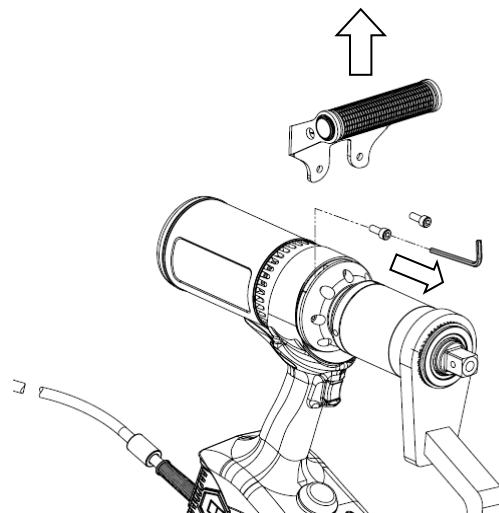

FIGURE 3 – Removal of Top Handle

2. Install two infills (supplied) then re-fit bolts; see figure 4.
The infills must be fitted to maintain the tool's environmental rating.

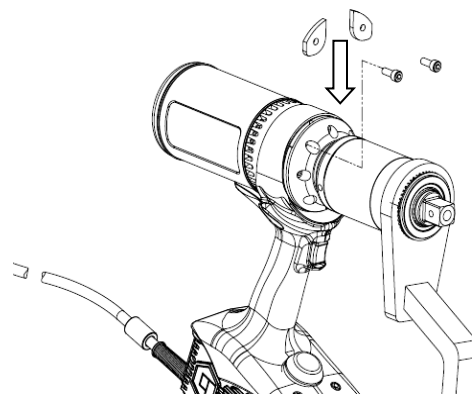



FIGURE 4 – Install infills

Torque Reaction

The reaction bar ensures all reaction forces are contained, so torque reaction is not passed back to the operator. Several reaction bar styles are available.

Fit reaction bar as detailed below.

Reaction Bar Type	Fitting Instructions
Cranked Reaction Bar (Standard) Single Sided Reaction Plate (Option) Double Sided Reaction Plate (Option)	Fit reaction bar / plate over the drive square to engage reaction splines. Secure with circlip supplied.
Nose Extension (Option)	Fit as per instructions supplied with nose extension. <div style="text-align: center;">  <p>FIGURE 5 – Nose Extension</p> </div>

It is essential the reaction bar rests squarely against a solid object or surface adjacent to the fastener to be tightened.

DO NOT react on the surface circled in red on figure 6.

React on the end of the reaction bar, circled in green on figure 6, using the maximum area possible.



FIGURE 6 – Cranked Reaction Bar (Steel or Aluminium)

The ideal reaction arrangement has the centre of the reaction bar and the centre of the nut on a perpendicular line to the centre line of the tool, see figure 7.

The supplied reaction bar has been designed to give an ideal reaction point when used with a standard length socket.

To allow for a small difference in socket length the reaction bar may contact any point within the shaded area of figure 7.

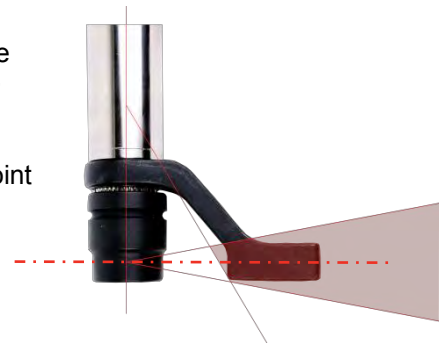

FIGURE 7 – Standard Length Socket Safe Reaction Window



WARNING: IF THE REACTION POINT IS OUTSIDE THE SHADED AREA EXCESSIVE LOADS MAY BE PLACED ON THE TOOL LEADING TO POTENTIAL OPERATOR INJURY AND DAMAGE TO THE TOOL.

If an extra long socket is used it may move the reaction bar outside the safe reaction window, as seen in figure 8.

The standard reaction bar may need to be extended to ensure it remains within the shaded area.

For alternative reaction bars see ACCESSORIES list.



**FIGURE 8 – Extra Long Socket
Safe Reaction Window**



WARNING: IF MODIFYING THE STANDARD REACTION BAR ENSURE IT IS CAPABLE OF TAKING THE MAXIMUM LOAD OF THE TOOL. FAILURE OF THE REACTION BAR CAN ENDANGER OPERATOR SAFETY AND DAMAGE THE TOOL.

Standard drive square extensions, see figure 9, **MUST NOT** be used as these will cause serious damage to the tool output drive.

A range of nose extensions is available for applications where access is restricted. These are designed to support the final drive correctly.



FIGURE 9 – Drive Square Extension

The dimensions of the standard reaction bars are shown in the following table:

Steel Reaction Bar (Supplied)	Tool	'L'	'A'	'B'	'W'	'SQ'
	ET2-72	77	167	124	29	3/4" or 1"
	ET2-92	75	175	125	29	1"
	ET2-119	95	210	161	35	1 1/2"

FIGURE 10 – Reaction Bar

Blade Nose Extension (Optional Accessory)	Tool	'L'	'A'	'B'	'W'	'SQ'
	ET2-72 (1000 N·m)	80.5	110	63	12	3/4"
	ET2-92 (2000 N·m)	51.5	110	62	16	1"

FIGURE 11 – Blade Nose Extension



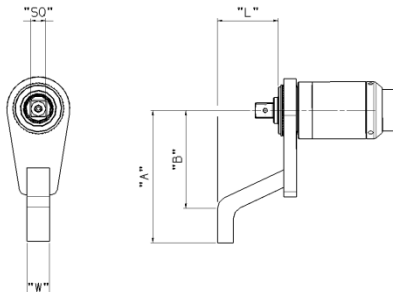

Nose Extension for Truck and Bus Wheels (Optional Accessory)	L	A	B	C	ØD	ØE	SQ
	98	47	132.5	29	52	38	3/4" or 1"

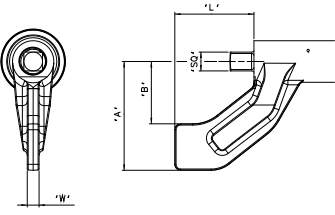
FIGURE 12 – Nose Extension for Truck and Bus Wheels

When the EvoTorque[®] 2 is in operation the reaction bar rotates in the opposite direction to the output drive square and must be allowed to rest squarely against a solid object or surface adjacent to the fastener to be tightened. (See figure 13 - 16).

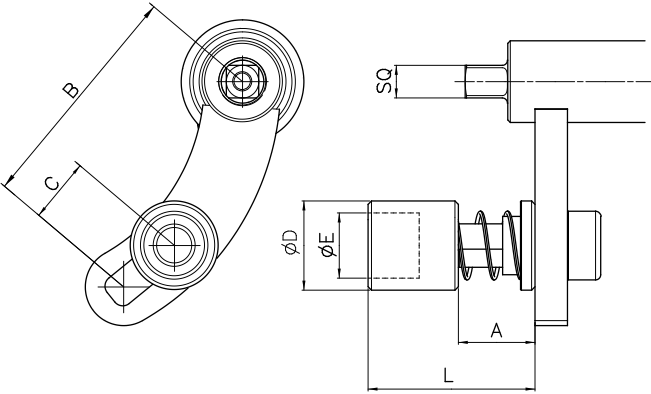
EvoTorque [®] 2 Type	Torque Reaction	
	Clockwise	Counter – Clockwise
Example of EvoTorque [®] 2 Tool	 <p>FIGURE 13</p>	 <p>FIGURE 14</p>
Example of EvoTorque [®] 2 tool with nose extension option	 <p>FIGURE 15</p>	 <p>FIGURE 16</p>



WARNING: ALWAYS KEEP HANDS CLEAR OF THE REACTION BAR WHEN THE TOOL IS IN USE OR SERIOUS INJURY MAY RESULT.



Connecting Supply



WARNING: THE TOOL HAS BEEN DESIGNED FOR ONE VOLTAGE ONLY. CHECK THAT THE POWER SUPPLY CORRESPONDS TO THE VOLTAGE ON THE TOOL RATING PLATE.



WARNING: THE TOOL MUST BE EARTHED ENSURE POWER SUPPLY HAS AN EARTH DO NOT OPERATE WITHOUT AN EARTH



WARNING: FOR OPERATOR SAFETY ENSURE THE MAINS SUPPLY HAS A RESIDUAL CURRENT DEVICE (RCD). TEST THE RCD REGULARLY.

Connect plug to local mains supply.

TIP: Supply Circuit Breaker:

If the mains supply is fitted with a circuit breaker ensure it is TYPE C (as defined in IEC / EN 60898-1) or above to eliminate false trips.

To maintain the environmental rating the tool has been factory fitted with a suitable plug to IEC 60309.

The plug will either be coloured blue (for 230 V a.c. models) or yellow (for 110 V a.c. models).

It is important to connect directly to a local supply socket outlet of the same type.

TIP: Use of a Different Local Supply Socket:

The tool is supplied with a plug rated to IEC 60309 for industrial locations.

An adaptor (where supplied) can be used to convert to a non-industrial plug; see INTRODUCTION for plug options.

Should a different plug be required, the mains cable colours are:

BROWN-LIVE

BLUE-NEUTRAL

GREEN/YELLOW-EARTH

The new plug must have a ground (**EARTH**) connection.
Ensure the plug is rated for voltage/current of tool.
If in doubt consult a qualified electrician.

TIP: Using an Extension Cable:

If an extension cable is required, use an approved extension cable suitable for the power input of this tool. The minimum conductor size is 1.5 mm². When using the cable reel, always unwind the cable completely.

Turn On

Turn on mains supply. Change ON/OFF switch from 0 to I.

The logo is shown for 2 seconds:

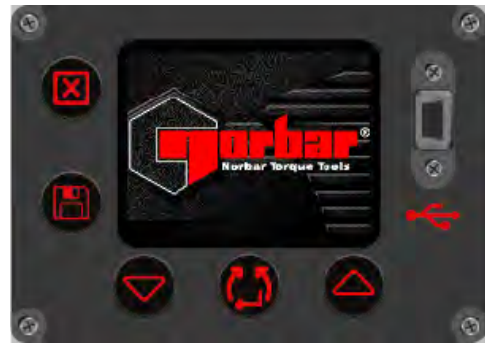

FIGURE 17 – Norbar Logo

The capacity is shown for 2 seconds:

TIP: Fan operation: During the logo & capacity screens the fan will run to give confirmation that it is working.



FIGURE 18 – Tool Capacity, Operational Voltage, Time & Date

The target screen is shown:

The Target and direction are remembered from the last use.

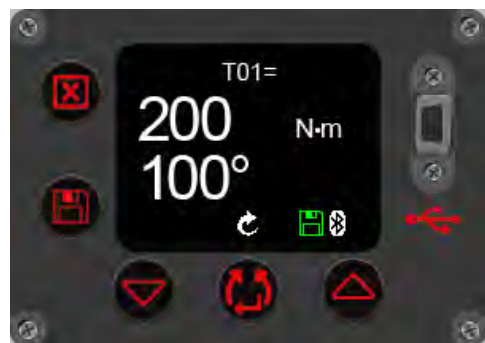

FIGURE 19 – Torque & Angle Target

Set Direction

Press  to set direction. This cannot be done when the tool is running.



FIGURE 20 – Set Direction

The tool is now ready to use. Press trigger and the following screen will be shown.

TIP: The tool operation is dependant on the Target Set Up i.e. Torque, Torque & Angle or Torque Audit.

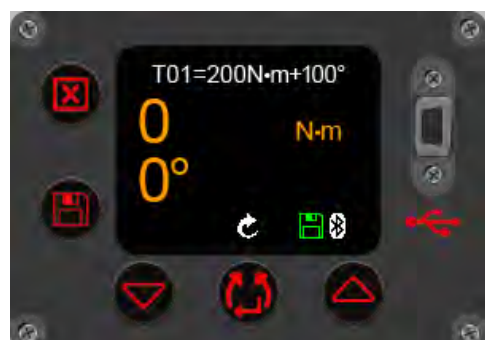





FIGURE 21 – Run screen



Set Up Targets

Press  to exit the Run screen and show the Menu screen.

Select  and press  to view targets.

Press  or  to highlight required Target # (T01 – T20).

Press  to enter Target Set Up / edit.

Press  to increase,  decrease the Torque Target value.

TIP: Keep button pressed for rapid rate of target change.

When set press  to accept.



Press  to increase,  to decrease Angle Target value. This is angle applied after torque is applied.

TIP: Keep button pressed for rapid rate of angle target change.

If in doubt leave as 0°

When set press  to accept.

NOTE: This screen will only be shown if the angle target was '0°' on the previous screen.

Press  or  to enable '✓' or disable '✗'.

When set press  to accept.

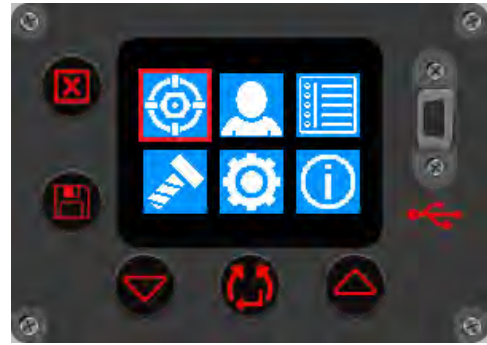

FIGURE 22 – Select Target Set Up



FIGURE 23 – Select Target #



FIGURE 24 – Set Target Torque



FIGURE 25 – Set Target Angle

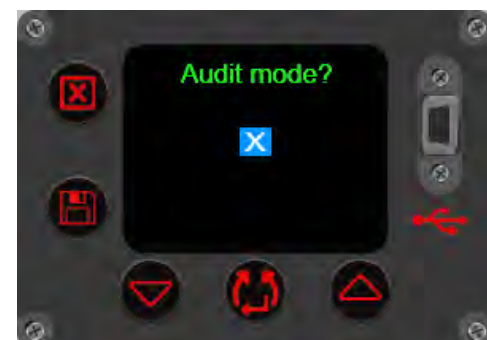

FIGURE 26 – Set Audit Target

NOTE: This screen will only be shown if the Audit mode? was '✓' on the previous screen.



Press   to increase/decrease the Tolerance value.
This is the expected / allowable angle the bolt can move on by.



FIGURE 27 – Set Tolerance

View / Select Work Groups & Work IDs

Press  to View/Select the Work Group or any standalone Work IDs on the tool. These can only be populated on the tool via EvoLog, see EvoLog Operator's Manual part # 34427 for more details.



FIGURE 28 – View / Select Work Groups & Work ID's

View / Select Users

Press  to View/Select any User IDs on the tool. These can only be populated on the tool via EvoLog, see EvoLog Operator's Manual part # 34427 for more details.



FIGURE 29 – View / Select Users

Tool Settings

This menu is used to set or view the Unit, Auto Reset, Lock, Bluetooth®, Time & Date, Output Format, Display and Tolerance.



FIGURE 30 – Tool Settings Menu



FIGURE 31 – Tool Set Up options 1

The Lock screen will appear if 'Lock' has been set.



FIGURE 32 – Unlock Tool

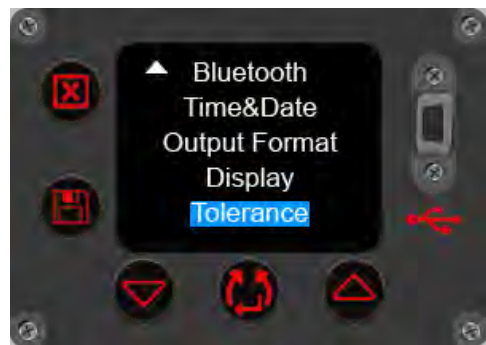





FIGURE 33 – Tool Set Up options 2

Enter PIN code to unlock using the  or  buttons.

Confirm each number by pressing the  button.

Menu Option	Details
Units	Select N·m, lbf·ft, ft·lb or kgf·m.
Auto Reset	✓ = Enabled (Hold time 2 -10 seconds) / ✗ = disabled (Manual Reset).
Lock	<p>✓ = Enabled (default PIN = 5000).The PIN can be set anywhere in the range 0000 to 9999.</p> <p>✗ = disabled.</p> <p>TIP: Keep a note of the pin code in a safe place</p>
Bluetooth®	✓ = Enabled (Bluetooth® Smart) / ✗ = disabled.
Time & Date	hh:mm:ss dd – mm - yy
Output Format	USER (CSV output for use outside of EvoLog) / EvoLog
Display	✓ = Inverse Enabled / ✗ = Inverse disabled.
Tolerances	Torque 3% default (range 3 – 20), Angle 2° default (range 2 – 20)

View Results (example screens)

Press  to exit the Run screen and show the Menu screen.

Select  and press  to view results.



FIGURE 34 – Select View Results

Press  to View Results.

Erase all will delete all of the results stored on the tool.

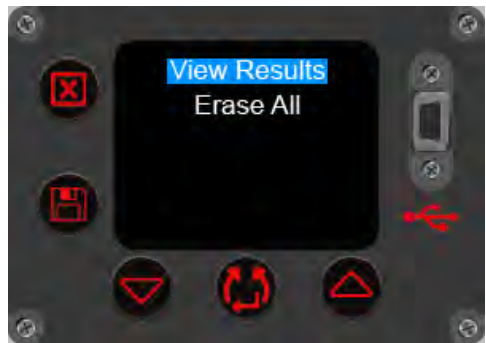



FIGURE 35 – Select View Results / Erase All

This example screen shows a Work Group called 'Carrier Hub 1' that was in use for the following saved results. All results are time and date stamped.

Press  or  to scroll through saved readings.

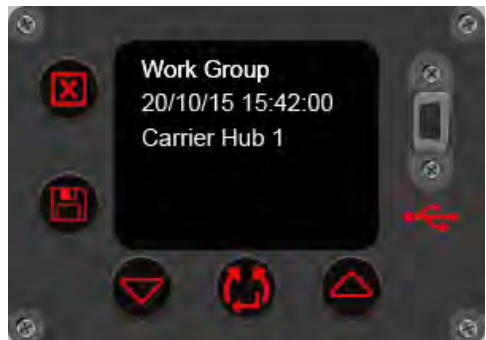

FIGURE 36 – View Work Group

This example screen shows a Work ID called 'Pretensioning' that was in use for the following saved results.

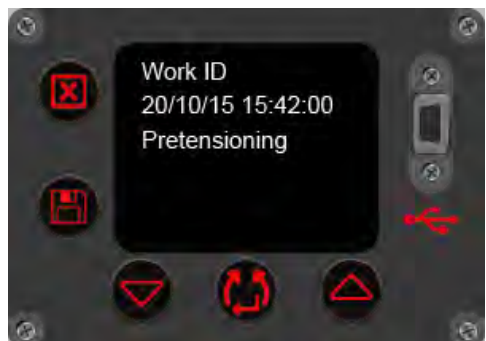

FIGURE 37 – View Work ID

This example screen shows a User ID called 'John Smith' that was in use for the following saved results.



FIGURE 38 – View User ID

This example screen shows a 400 N·m Audit result.



FIGURE 39 – View Result

Press  to display the memory Record #.



FIGURE 40 – View Record #

Tool Information

Press  to select View Tool Information to begin a cycle through tool information screens. The Tool Capacity, Voltage and Date/Time will be shown first. (see Figure 42 below).



FIGURE 41 – Select View Tool Information

Press  to continue cycle. The Tool Serial # and Tool Name will then be shown (see Figure 43 below).



FIGURE 42 – View Tool Capacity, Voltage, Date/Time.

Press  to continue cycle and show installed software versions (see Figure 44 below).



FIGURE 43 – View Tool Serial # / Name

Press  to continue cycle and show the Bluetooth® Smart screen (see Figure 45 below).



FIGURE 44 – View Motor / Display Software Version #'s

Press  to continue cycle and show the Error Log (see Figure 46 below).



FIGURE 45 – Bluetooth® Smart



Press  to continue cycle and show the Tool Statistics (see Figure 47 below).



FIGURE 46 – View Error Log

This screen shows the usage statistics for the tool.

Press  to end the cycle and return to the menu screen (see Figure 41).

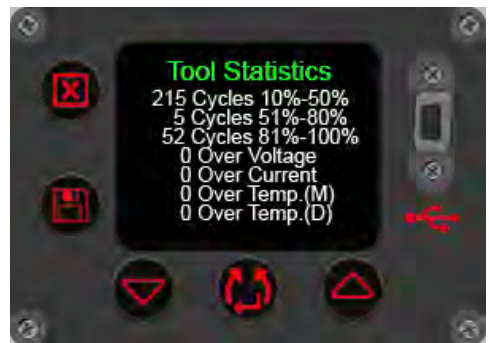

FIGURE 47 – View Tool Statistics

OPERATING INSTRUCTIONS



WARNING: KEEP HANDS CLEAR OF THE REACTION BAR.



WARNING: WHEN USING THIS TOOL IT MUST BE SUPPORTED AT ALL TIMES IN ORDER TO PREVENT UNEXPECTED RELEASE IN THE EVENT OF FASTENER OR COMPONENT FAILURE.

Tightening

1. Fit the tool with the correct size impact or high quality socket to suit fastener.

TIP: For added safety it is recommended to secure the socket to the drive square. This is often achieved using a pin and O ring, see socket manufacturer for guidance.

2. Ensure the Clockwise/Counter-clockwise display arrow is correct.



Press  to change direction (if required).

3. Ensure Torque, Torque & Angle or Audit Torque target shown is correct.

Torque

In Torque mode the tool applies torque until the target torque is achieved.

Torque and Angle

Torque and Angle is achieved in 2 steps, see figure 48:

- 3.1. The tool applies a torque.
Ensure fastener has been pre-torqued above this value.
- 3.2. The tool applies the target angle.

Audit Torque

Audit Torque is intended for checking. The tool runs slower and gives a Torque and Angle result.

4. Rotate the handle into a convenient position relative to the reaction bar.
Fit the tool onto the fastener to be tightened with the reaction bar adjacent to the reaction point. See figure 49.
5. Adopt a posture to counteract normal or unexpected movement of the tool due to reaction forces.
6. Press and release trigger to slowly bring reaction bar into contact with the reaction point.

NOTE: Bringing into contact at speed can lead to increased operator danger, fastener damage, reaction point damage and torque inaccuracies especially on high torque rate joints.

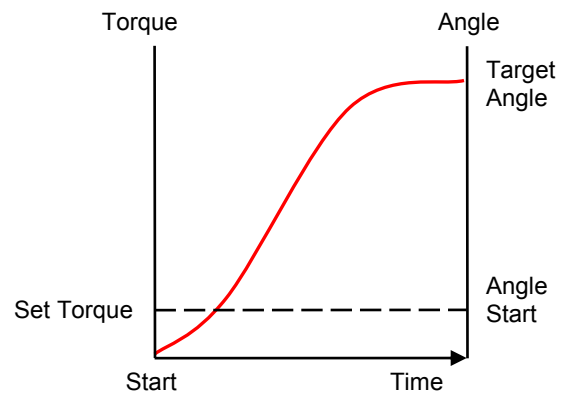

FIGURE 48 – Angle Mode



FIGURE 49 – Clockwise Operation

7. Fully press the trigger and keep fully pressed until tool stops, then release trigger.

8. Joint complete. See colour of displayed value for pass / fail status.



FIGURE 50 – Torque Target result (shown as red for fail)

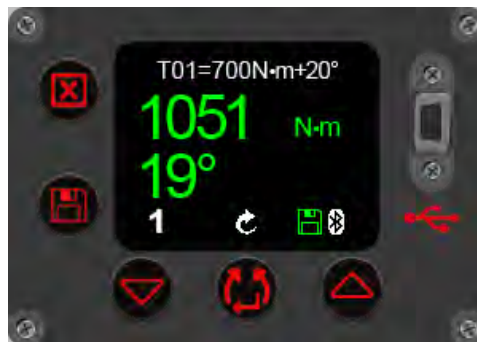

FIGURE 51 – Torque & Angle target result (shown as green for pass)

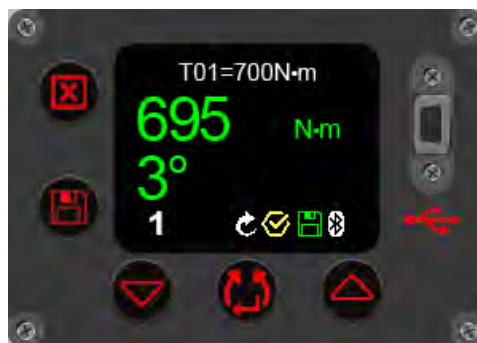

FIGURE 52 – Audit Torque target result (showing achieved torque and output (bolt) movement in degrees)





LED Status	Meaning	Delay To Next Run	Action
● ✓	Fastener tightened to specification.	2 seconds	None
● ✗	Fastener NOT tightened to specification.	2 seconds	Release fastener and re-tighten

9. Remove the tool from the fastener.

TIP: When tightening multiple fasteners on a flange it is recommended to mark each fastener when tight.

This is even more important when using the TORQUE & ANGLE mode as applying additional angle to a tightened fastener will increase the risk of operator danger, fastener damage and flange damage.

Saving Results

Auto Reset =	Button Operation (after a successful tightening)
X	<p>Press either the  or  buttons to Save the displayed (joint complete) reading and reset the tool, ready for the next tightening operation.</p> <p>Press the  button will reset the tool ready for the next tightening operation without saving the (joint complete) reading.</p>
✓	<p>Press the  button to toggle between Save and No Save.</p> <p>When the Save icon  is displayed, the next displayed (joint complete) reading will be saved and automatically reset the tool ready for the next tightening operation after the 'Hold Time' setting has expired.</p> <p>The next displayed (joint complete) reading will not be saved if the icon is not shown.</p>

NOTE: The Save icon will be shown in red when the tool is in 'Logging' mode. See EvoLog operators manual (part number 34427) for more details.

Releasing

1. Fit the EvoTorque[®]2 with the correct size impact or high quality socket to suit the fastener to be released.

TIP: For added safety it is recommended to secure the socket to the drive square. This is often achieved using a pin and O ring, see socket manufacturer for guidance.

2. Ensure the clockwise/counter-clockwise display arrow is correct.

Press  to set direction.

3. Rotate the handle into a convenient position relative to the reaction bar. Fit the tool onto the fastener to be released with the reaction bar adjacent to the reaction point. See figure 53.
4. Adopt a posture to counteract normal or unexpected movement of the tool due to reaction forces.
5. Press and release trigger to slowly bring reaction bar into contact with the reaction point.
6. Fully press the trigger and keep fully pressed until the threaded fastener releases.



FIGURE 53 – Anti-Clockwise Operation

TIP: If unable to release the fastener, increase the target torque. The tool will automatically limit itself to the maximum tool output torque.

MAINTENANCE



WARNING: ENSURE THE TOOL IS DISCONNECTED FROM MAINS SUPPLY BEFORE MAINTENANCE.

For optimum performance and safety, regular tool maintenance is required. The user maintenance is limited to that stipulated in this section. Any other maintenance or repairs should be carried out by Norbar or a Norbar distributor. Maintenance intervals will depend on the tool usage and the environment in which it is being used. The maximum recommended maintenance and recalibration interval is 12 months.

TIP: Steps the user can take to reduce the amount of maintenance required include:

- 1. Use the tool in a clean environment**
- 2. Maintain the correct torque reaction**
- 3. Carry out daily checks**

Daily Checks

It is recommended to check the overall condition of the tool every day.

Check power cord for damage – if faulty contact Norbar or Norbar distributor.

Ensure PAT test on tool is within date.

Test the external RCD in the mains supply (if fitted).

Ensure tool is clean - DO NOT use abrasives or solvent based cleaners.

Ensure fan and ventilation slots are clean and dust free. If cleaned with compressed air wear eye protection.

Free run tool to ensure motor and gearbox are smooth and quiet.

Calibration

Your tool has been supplied with a certificate of calibration.

To maintain the specified accuracy it is recommended that the tool is recalibrated at least once per year.

Recalibration should be carried out at Norbar or by a Norbar distributor, where all the facilities to ensure the instrument is functioning at maximum accuracy are available.

Do not remove tool casing; there are no calibration settings inside.

Portable Appliance Testing

Portable Appliance Testing (PAT testing) is officially known as “In-service Inspection & Testing of Electrical Equipment”.

This is often a mandatory requirement in local regulations or factory procedures.

The tests are to ensure that the equipment has not suffered damage or faults in the electrical connections that could cause potential danger to the operator.

A competent person should inspect then test the tool for earth continuity (Earth Bond) and Insulation resistance (Electric Strength); other tests may apply.

The frequency of test will depend on many factors including the tool application and environment.

Gearbox

Under normal operating conditions it is not necessary to re-grease the gearbox. The gearbox contains Lubcon Turmogrease Li 802 EP.

Drive Square

If the tool output drive is subject to torque overload there is potential for catastrophic tool damage. To reduce this risk the output drive square has been designed, like a fuse, so it will shear first. The output drive square is easy and quick to replace, for part numbers see ACCESSORIES listed in the INTRODUCTION. The drive square is NOT covered by the standard product warranty.



FIGURE 54 – Drive Square Replacement

To replace the drive square:

1. Unplug tool from mains supply.
2. Support tool in a horizontal position
3. Use 4mm hex key (supplied) to remove the screw and then remove drive square.
If the square has sheared it may be necessary to use pliers to remove the broken parts.
4. Fit new drive square.
5. Fit new screw. Tighten to 9 N·m (M5).

TIP: If the drive square fails continually then seek advice from Norbar or a Norbar distributor.

Product Disposal



This symbol on the product indicates that it must not be disposed of in the general waste.

Please dispose of according to your local recycling laws and regulations. Contact your distributor or see the Norbar website (www.norbar.com) for further recycling information.

SPECIFICATIONS - EvoTorque®2

Part Number	Torque		Tool Speed* (Free Running)	Tool Weight (kg)	Reaction Weight (kg)	Case & Ancillaries (kg)
	Minimum	Maximum				
180220.B06 180230.B06	100 N·m	1000 N·m	21 rpm	10.4	1.5	6.0
180221.B06 180231.B06	135 N·m	1350 N·m	17 rpm	10.4	1.5	6.0
180222.B08 180232.B08	200 N·m	2000 N·m	11 rpm	10.8	1.5	6.0
180223.B08 180233.B08	270 N·m	2700 N·m	8.5 rpm	12.85	2.6	6.0
180224.B08 180234.B08	400 N·m	4000 N·m	6 rpm	12.85	2.6	6.0
180225.B12 180235.B12	600 N·m	6000 N·m	3.3 rpm	16.8	3.9	6.0
180226.B12 180236.B12	700 N·m	7000 N·m	TBA	TBA	TBA	TBA

* = Tool speed is reduced for Angle mode, Audit mode and for <20% capacity targets.

NOTE: Tools are calibrated from 20% to 100% of the maximum operating range.

Part Number	Dimensions (mm)					
	B	C	D	E	F	G
180220.B06 180230.B06	390	435	77	72	100	135.5
180221.B06 180231.B06	390	435	77	72	100	135.5
180222.B08 180232.B08	425	435	77	72	100	135.5
180223.B08 180233.B08	450	435	75	92	100	135.5
180224.B08 180234.B08	450	435	75	92	100	135.5
180225.B12 180235.B12	480	435	95	119	115	135.5
180226.B12 180236.B12	TBA	TBA	TBA	TBA	TBA	TBA

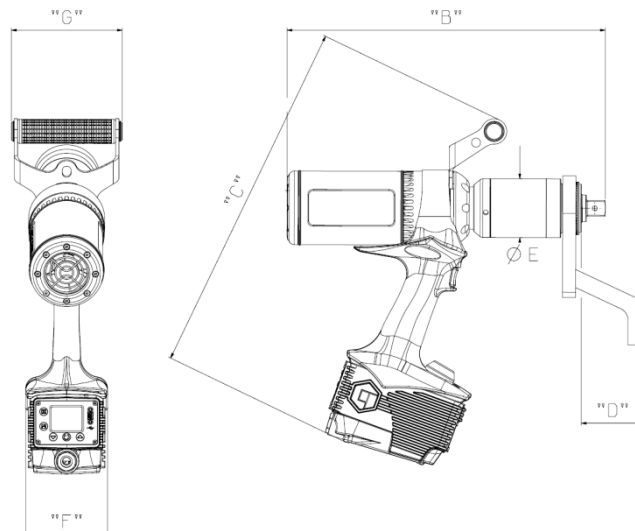

FIGURE 55 – Tool Dimensions

Torque Accuracy:	±3% of target torque on 100° joint for calibrated range (see calibration certificate).
Torque Setting:	10% to 100% of tool capacity.
Angle Accuracy:	±2°.
Angle Setting:	10° to 720°.
Angle Start Threshold:	10% to 100% of tool capacity.
Display:	Colour OLED (160 x 128 pixels)
USB	2.0
Bluetooth®:	Bluetooth® Smart 4.0
	“Contains Transmitter Module FCC ID: QOQBLE112” “Contains Transmitter Module IC: 5123A-BGTBLE112”
	Wireless range tested to 6m. Can work over 20m in an ideal environment.
Memorized readings:	3000
Vibration:	The vibration total value does not exceed 2.5m/s ² . Highest measured tool vibration $a_h = 0.304 \text{ m/s}^2$. The declared vibration total value has been measured in accordance with a standard test method and may be used for comparing one tool with another. The declared vibration total value may also be used in a preliminary assessment of exposure.



WARNING: THE VIBRATION EMISSION DURING ACTUAL USE OF THE POWER TOOL CAN DIFFER FROM THE DECLARED TOTAL VALUE DEPENDING ON THE WAYS IN WHICH THE TOOL IS USED.



WARNING: IDENTIFY SAFETY MEASURES TO PROTECT THE OPERATOR THAT ARE BASED ON AN ESTIMATION OF THE EXPOSURE IN THE ACTUAL CONDITIONS OF USE (TAKING ACCOUNT OF ALL PARTS OF THE OPERATING CYCLE SUCH AS THE TIMES WHEN THE TOOL IS SWITCHED OFF AND WHEN IT IS RUNNING IDLE IN ADDITION TO THE TRIGGER TIME).

Sound Pressure Level:	L_{pA} does not exceed 70 dB(A).
Ingress Protection:	IP44 (Protection against 1mm solid objects & splashing water) see EN 60529.
Environment:	Industrial. Store in a clean and dry environment.
Temperature Range:	-20°C to +50°C (operating). -20°C to +60°C (storage).
Operating Humidity:	85% Relative Humidity @ 30°C maximum.
Voltage Requirement:	110 V a.c. (99-132 V a.c.) or 230 V a.c. (198-264 V a.c.) at 50-60Hz, see Tool Rating Plate.
Current Requirement:	10A (for 110 V a.c. tools) or 5A (for 230 V a.c. tools).
Fuse Fitted:	15A (for 110 V a.c. tools) or 12A (for 230 V a.c. tools).

Due to continuous improvement all specifications are subject to change without prior notice.

NOTE: If equipment is used in a manner not specified by the manufacturer, the protection provided by the equipment could be impaired.

SPECIFICATIONS - USB Bluetooth[®] Smart adapter



FCC and IC

This equipment has been tested and found to comply with the limits for a Class B digital device, pursuant to Part 15 of the FCC Rules. These limits are designed to provide reasonable protection against harmful interference in a residential installation.

This equipment generates, uses and can radiate radio frequency energy and, if not installed and used in accordance with the instructions, may cause harmful interference to radio communications. However, there is no guarantee that interference will not occur in a particular installation. If this equipment does cause harmful interference to radio or television reception, which can be determined by turning the equipment off and on, the user is encouraged to try to correct the interference by one of the following measures:

- Reorient or relocate the receiving antenna
- Increase the separation between the equipment and receiver
- Connect the equipment into an outlet on a circuit different from that to which the receiver is connected
- Consult the dealer or an experienced radio/TV technician for help

FCC Caution : To assure continued compliance, any changes or modifications not expressly approved by the party responsible for compliance could void the user's authority to operate this equipment. (Example - use only shielded interface cables when connecting to computer or peripheral devices).

FCC Radiation Exposure Statement

This equipment complies with FCC RF radiation exposure limits set forth for an uncontrolled environment. This device complies with Part 15 of the FCC Rules. Operation is subject to the following two conditions:

- (1) This device may not cause harmful interference, and
- (2) This device must accept any interference received, including interference that may cause undesired operation.

Industry Canada

IC Statements:

This device complies with Industry Canada licence-exempt RSS standard(s). Operation is subject to the following two conditions: (1) this device may not cause interference, and (2) this device must accept any interference, including interference that may cause undesired operation of the device.

Under Industry Canada regulations, this radio transmitter may only operate using an antenna of a type and maximum (or lesser) gain approved for the transmitter by Industry Canada. To reduce potential radio interference to other users, the antenna type and its gain should be so chosen that the equivalent isotropically radiated power (e.i.r.p.) is not more than that necessary for successful communication.

Déclaration d'IC :

Ce dispositif est conforme aux normes RSS exemptes de licence d'Industrie Canada. Son fonctionnement est assujéti aux deux conditions suivantes : (1) ce dispositif ne doit pas provoquer de perturbation et (2) ce dispositif doit accepter toute perturbation, y compris les perturbations qui peuvent entraîner un fonctionnement non désiré du dispositif.

Selon les réglementations d'Industrie Canada, cet émetteur radio ne doit fonctionner qu'avec une antenne d'une typologie spécifique et d'un gain maximum (ou inférieur) approuvé pour l'émetteur par Industrie Canada. Pour réduire les éventuelles perturbations radioélectriques nuisibles à d'autres utilisateurs, le type d'antenne et son gain doivent être choisis de manière à ce que la puissance isotrope rayonnée équivalente (P.I.R.E.) n'excède pas les valeurs nécessaires pour obtenir une communication convenable.

CE

USB Bluetooth® Smart adapter is in conformity with the essential requirements and other relevant requirements of the R&TTE Directive (1999/5/EC). The product is in conformity with the following standards and/or normative documents.

- EMC EN 301 489-17 V.1.3.3 in accordance with EN 301 489-1 V1.8.1
- Radiated emissions EN 300 328 V1.7.1
- Safety EN 60950-1

South-Korea

USB Bluetooth® Smart adapter is certified in South-Korea with certification number: KCC-CRM-BGT-BLED112

Japan

USB Bluetooth® Smart adapter has MIC Japan type certification with certification number: 003WWA111471

Brazil



Este equipamento opera em caráter secundário, isto é, não tem direito à proteção contra interferência prejudicial, mesmo de estações do mesmo tipo e não pode causar interferência a sistemas operando em caráter primário.



Norbar Torque Tools Ltd
 Wildmere Road | Banbury | Oxfordshire | OX16 3JU | UK
 T +44 (0)1295 270333 | F +44 (0)1295 753643
 E enquiry@norbar.com | www.norbar.com

QA57
 ISSUE 2
 24.1.97

EU Declaration of Conformity (No 0008)

This declaration of conformity is issued under the sole responsibility of the manufacturer.

The object of the declaration:

EvoTorque® 2. Model Name (Part Number):

- | | |
|-------------------------------|-------------------------------|
| ET2-72-1000-110 (180230.B06) | ET2-72-1000-230 (180220.B06) |
| ET2-72-1350-110 (180231.B06) | ET2-72-1350-230 (180221.B06) |
| ET2-72-2000-110 (180232.B08) | ET2-72-2000-230 (180222.B08) |
| ET2-92-2700-110 (180233.B08) | ET2-92-2700-230 (180223.B08) |
| ET2-92-4000-110 (180234.B08) | ET2-92-4000-230 (180224.B08) |
| ET2-119-6000-110 (180235.B12) | ET2-119-6000-230 (180225.B12) |
| ET2-119-7000-110 (180236.B12) | ET2-119-7000-230 (180226.B12) |



The object of the declaration described above is in conformity with the relevant union harmonisation legislation:

- Directive 2006/42/EC on Machinery Directive.
- Directive 2014/30/EU on Electromagnetic Compatibility.
- Directive 1999/5/EC on Radio equipment and Telecommunications Terminal Equipment.

The object of the declaration described above has been designed to comply with the following standards:

BS EN 60745-1:2009 + A11: 2010	Hand-held motor-operated electric tools. Safety. General requirements.
BS EN 60745-2-2:2010	Hand-held motor-operated electric tools. Safety. Part 2: Particular requirements for screwdrivers and impact wrenches.
BS EN 61000-3-2:2006 + A2: 2009	Electromagnetic compatibility (EMC). Limits. Limits for harmonic current emissions (equipment input current <=16 A per phase).
BS EN 61000-3-3: 2008	Electromagnetic compatibility (EMC). Limits. Limitation of voltage changes, voltage fluctuations and flicker in public low-voltage supply systems, for equipment with rated current ≤ 16 A per phase and not subject to conditional connection.
BS EN 61000-6-2: 2005	Electromagnetic compatibility (EMC). Generic standards. Immunity standard for industrial environments.
BS EN 61000-6-4: 2007 + A1: 2011	Electromagnetic compatibility (EMC). Generic standards. Emission standard for industrial environments.
EN 301 489-1 v.1.9.2	Article 3(1) of directive 1999/5/EC.
EN 301 489-17:V2.2.1	Radiated electric field immunity EN 61000-4-3:2006.
EN 300 328 V1.8.1	Article 3(2) of directive 1999/5/EC.

The basis on which conformity is being declared:

This declaration of conformity is issued under the sole responsibility of the manufacturer. The technical documentation required to demonstrate that the products meet the requirements of the above Directives has been compiled by the signatory below and is available for inspection by the relevant enforcement authorities.

The object of the declaration described above is in conformity with Directive 2011/65/EU of the European Parliament and of the Council of 8 June 2011 on the restriction of the use of certain hazardous substances in electrical and electronic equipment.

The CE mark was first applied in: 2016.

Signed for and on behalf of Norbar Torque Tools Ltd.

Signed: *T.M. Lester* **Full Name:** Trevor Mark Lester B.Eng.
Date: 29th March 2016 **Authority:** Compliance Engineer
Place: Norbar Torque Tools Ltd., Wildmere Road, Banbury, Oxfordshire. OX16 3JU



United Kingdom | Australia | United States of America
 New Zealand | Singapore | China | India



Registered in England No 380480 | VAT No GB 119 1060 05

TROUBLE SHOOTING

The following is only a guide, for more complex fault diagnoses please contact Norbar or a Norbar distributor.

Problem	Likely Reason	Likely Solutions
No Display	No mains power	Check electrical mains power is working
	External fuse or circuit breaker has operated	Check fuse or circuit breaker
	External RCD has operated	Check for faults then reset the RCD
Tool output does not rotate when trigger is pressed	Tool is on tight fastener	Remove from fastener Check correct setting of tool direction
	Tool is off	Ensure tool is ON (display lit)
	Tool is in set up mode	Exit set up to return to operate mode
	Output drive square sheared	See MAINTENANCE section to replace drive square
	Gear train or motor is damaged	Contact Norbar
Torque adjustment has no effect	Trigger is pressed	Release trigger
	In menu mode	Select exit
Red LED shown	Bolt has not made correct torque or angle	Trigger released early  Fastener sheared or thread stripped
	Tool error	Contact Norbar
E21 or E16 (error codes)	Tool slammed into fastener.	Bring reaction bar slowly into position.
	230 V tool used on 110 V supply	Use correct mains voltage.
Measured angle is less than EvoTorque® 2 applied	Flex in reaction bar or reaction point.	Ensure reaction bar & reaction point are rigid.
 "M=xx°C" Motor too hot.	Overuse at high torque.	Rest tool. The tool is not operational until this message clears.
	Cooling fan blocked / broken.	Turn tool off. Unblock / contact Norbar or a norbar distributor to fix fan.
 "D=xx°C" Display too hot.	Overuse at high torque.	Rest tool. The tool is not operational until this message clears.
Click sound from motor when not running.	Temperature measurement.	Normal operation.
E>1000 N·m, E>1350 N·m E>2000 N·m, E>2700 N·m E>4000 N·m, E>6000 N·m E>7000 N·m	Demand for torque greater than tool capacity.	Use larger capacity tool.
Logo flashes	Cooling fan is blocked / broken	Turn tool off. Unblock / contact Norbar or a norbar distributor to fix fan.
Tool runs slower for Torque only Targets < 20% capacity and Audit mode.	Normal operation.	Normal operation.

Problem	Likely Reason	Likely Solutions
	Slam joint. a) The reaction bar is moving too fast (tightening). b) Un-doing a tightened joint with too lower Target	Undo and re-tighten the joint. Use a larger Target value than the tightening Target.
Not working with EvoLog	Output Format has been set to CSV	Change the Output Format to EvoLog
Lost PIN number		Contact Norbar
Battery symbol shown in power up		Contact Norbar

GLOSSARY OF TERMS

Word or Term	Meaning
A	Amps
Audit	Checking a pre-tightened joint.
Auto reset	
a.c.	Alternating Current
A/F	Across Flats
Bi-directional	Clockwise and Counter Clockwise
CSV	Comma Separated Values
ET2	EvoTorque [®] 2
EvoLog	Software supplied with EvoTorque [®] 2 for data comparison and tool setting
EvoTorque [®] 2	Product Name
Fastener	Bolt or stud to be tightened
Nose Extension	A reaction type used where tool access is restricted, a typical example is on wheel nuts on heavy vehicles
Reaction Bar	Item to counteract applied torque. Also called Reaction Plate.
Record	A memory location. A Work Group, Work ID, User ID or Result saved in the tools memory.
RCD	Residual Current Device, for disconnecting the electrical supply in the case of a fault; so protecting the operator. A device with a trip value of 30mA or less is recommended.
Target Torque and Angle	The Torque, Torque & Angle or Audit Torque that the tool is set to achieve (when active). Applies a torque first and then an angle after.
Torque Rate	The increase in torque with angular displacement while advancing a fastener in a threaded joint (as defined in ISO 5393 Rotary Tools for Threaded Fasteners – Performance Test Method.) A LOW torque rate is often referred to as a SOFT joint. A HIGH torque rate is often referred to as a HARD joint.
User ID	Identification of the person using the tool.
V	Volts
Work ID	Identification of a group of Results.
Work Group	Specific group of a number of Work IDs and Targets.

NOTES

**NORBAR TORQUE TOOLS LTD**

Wildmere Road, Banbury, Oxfordshire,
OX16 3JU

UNITED KINGDOM

Tel + 44 (0)1295 753600

Email enquiry@norbar.com

**NORBAR TORQUE TOOLS PTE LTD**

194 Pandan Loop
#07-20 Pantech Business Hub
SINGAPORE 128383

Tel + 65 6841 1371

Email enquires@norbar.sg

**NORBAR TORQUE TOOLS**

45–47 Raglan Avenue, Edwardstown,
SA 5039

AUSTRALIA

Tel + 61 (0)8 8292 9777

Email enquiry@norbar.com.au

**NORBAR TORQUE TOOLS (SHANGHAI) LTD**

E Building–5F, no. 1618 Yishan Road,
Minhang District, Shanghai
CHINA 201103

Tel + 86 21 6145 0368

Email sales@norbar.com.cn

**NORBAR TORQUE TOOLS INC**

36400 Biltmore Place, Willoughby,
Ohio, 44094

USA

Tel + 1 866 667 2279

Email inquiry@norbar.us

**NORBAR TORQUE TOOLS INDIA PVT. LTD**

Plot No A-168, Khairne Industrial Area,
Thane Belapur Road, Mahape,
Navi Mumbai – 400 709

INDIA

Tel + 91 22 2778 8480

Email enquiry@norbar.in

www.norbar.com